

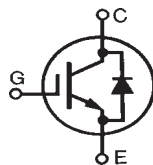
## High Speed IGBT with Diode

**IXSH 30N60B2D1**  
**IXST 30N60B2D1**

$V_{CES} = 600\text{ V}$   
 $I_{C25} = 48\text{ A}$   
 $V_{CE(sat)} = 2.5\text{ V}$

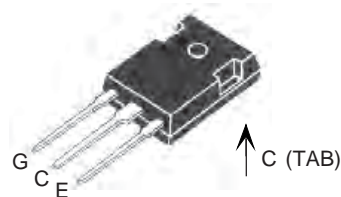
Short Circuit SOA Capability

Preliminary Data Sheet

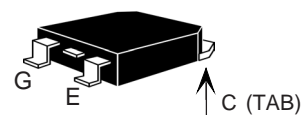


Symbol	Test Conditions	Maximum Ratings	
$V_{CES}$	$T_J = 25^\circ\text{C to } 150^\circ\text{C}$	600	V
$V_{CGR}$	$T_J = 25^\circ\text{C to } 150^\circ\text{C}; R_{GE} = 1\text{ M}\Omega$	600	V
$V_{GES}$	Continuous	$\pm 20$	V
$V_{GEM}$	Transient	$\pm 30$	V
$I_{C25}$	$T_C = 25^\circ\text{C}$	48	A
$I_{C110}$	$T_C = 110^\circ\text{C}$	30	A
$I_{F(110)}$		28	A
$I_{CM}$	$T_C = 25^\circ\text{C}, 1\text{ ms}$	90	A
<b>SSOA (RBSOA)</b>	$V_{GE} = 15\text{ V}, T_J = 125^\circ\text{C}, R_G = 10\Omega$ Clamped inductive load	$I_{CM} = 48$ @ $0.8 V_{CES}$	A
<b><math>t_{SC}</math> (SCSOA)</b>	$V_{GE} = 15\text{ V}, V_{CE} = 360\text{ V}, T_J = 125^\circ\text{C}$ $R_G = 10\Omega$ , non repetitive	10	$\mu\text{s}$
$P_C$	$T_C = 25^\circ\text{C}$	250	W
$T_J$		-55 ... +150	$^\circ\text{C}$
$T_{JM}$		150	$^\circ\text{C}$
$T_{stg}$		-55 ... +150	$^\circ\text{C}$
<b>Weight</b>	TO-247	6	g
	TO-268	5	g
Maximum lead temperature for soldering 1.6 mm (0.062 in.) from case for 10 s		300	$^\circ\text{C}$
Maximum tab temperature for soldering for 10s		260	$^\circ\text{C}$

TO-247 (IXSH)



TO-268 (IXST)



G = Gate      C = Collector  
E = Emitter    TAB = Collector

### Features

- International standard package
- Guaranteed Short Circuit SOA capability
- Low  $V_{CE(sat)}$ 
  - for low on-state conduction losses
- High current handling capability
- MOS Gate turn-on
  - drive simplicity
- Fast fall time for switching speeds up to 20 kHz

### Applications

- AC motor speed control
- Uninterruptible power supplies (UPS)
- Welding

### Advantages

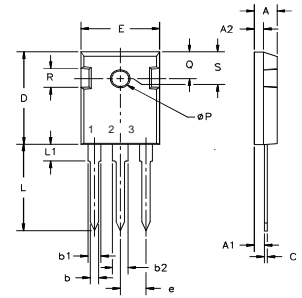
- High power density

Symbol	Test Conditions	Characteristic Values			
		$(T_J = 25^\circ\text{C}, \text{ unless otherwise specified})$			
		min.	typ.	max.	
$V_{GE(th)}$	$I_C = 750\ \mu\text{A}, V_{CE} = V_{GE}$	4.0		7.0	V
$I_{CES}$	$V_{CE} = V_{CES}$ $V_{GE} = 0\text{ V}$			150	$\mu\text{A}$
				1	mA
$I_{GES}$	$V_{CE} = 0\text{ V}, V_{GE} = \pm 20\text{ V}$			$\pm 100$	nA
$V_{CE(sat)}$	$I_C = 24\text{ A}, V_{GE} = 15\text{ V}$			2.5	V

Symbol	Test Conditions	Characteristic Values ( $T_J = 25^\circ\text{C}$ , unless otherwise specified)		
		min.	typ.	max.
$g_{fs}$	$I_C = 24\text{A}; V_{CE} = 10\text{V}$ , Note 1	7.0	12.0	S
$C_{ies}$	$V_{CE} = 25\text{V}, V_{GE} = 0\text{V}$ $f = 1\text{MHz}$ 20N60B2D1		1220	pF
$C_{oes}$			110	pF
			140	pF
$C_{res}$			42	pF
$Q_g$			50	nC
$Q_{ge}$	$I_C = 24\text{A}, V_{GE} = 15\text{V}, V_{CE} = 0.5 V_{CES}$		23	nC
$Q_{gc}$			15	nC
$t_{d(on)}$	<b>Inductive load, <math>T_J = 25^\circ\text{C}</math></b>		30	ns
$t_{ri}$	$I_C = 24\text{A}, V_{GE} = 15\text{V}$ $V_{CE} = 400\text{V}, R_G = 5\ \Omega$		30	ns
$t_{d(off)}$	Switching times may increase for $V_{CE}$ (Clamp) $> 0.8 \cdot V_{CES}$ , higher $T_J$ or increased $R_G$		130	280 ns
$t_{fi}$			140	300 ns
$E_{off}$			0.55	1.0 mJ
$t_{d(on)}$	<b>Inductive load, <math>T_J = 125^\circ\text{C}</math></b>		30	ns
$t_{ri}$			50	ns
$E_{on}$	$I_C = 24\text{A}, V_{GE} = 15\text{V}$ $V_{CE} = 400\text{V}, R_G = 5\ \Omega$	20N60B2 20N60B2D1	0.32	mJ
	Switching times may increase for $V_{CE}$ (Clamp) $> 0.8 \cdot V_{CES}$ , higher $T_J$ or increased $R_G$		0.82	mJ
$t_{d(off)}$			202	ns
$t_{fi}$			234	ns
$E_{off}$			1.18	mJ
$R_{thJC}$				0.50 K/W
$R_{thCS}$			0.21	K/W

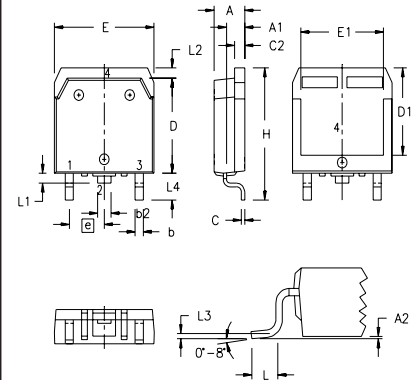
Symbol	Test Conditions	Characteristic Values ( $T_J = 25^\circ\text{C}$ , unless otherwise specified)		
		min.	typ.	max.
$V_F$	$I_F = 30\text{A}, V_{GE} = 0\text{V}$	$T_J = 150^\circ\text{C}$		1.6 V 2.5 V
$I_{RM}$	$I_F = 50\text{A}, V_{GE} = 0\text{V}, -di_F/dt = 100\text{A}/\mu\text{s}$	$T_J = 100^\circ\text{C}$	2.0	2.5 A
$t_{rr}$	$V_R = 100\text{V}$	$T_J = 100^\circ\text{C}$	150	ns
$t_{rr}$	$I_F = 1\text{A}; -di/dt = 100\text{A}/\mu\text{s}; V_R = 30\text{V}$		30	ns
$R_{thJC}$				0.9 K/W

Note 1: Pulse test,  $t \leq 300\ \mu\text{s}$ , duty cycle  $d \leq 2\%$

**TO-247 (IXSH) Outline**


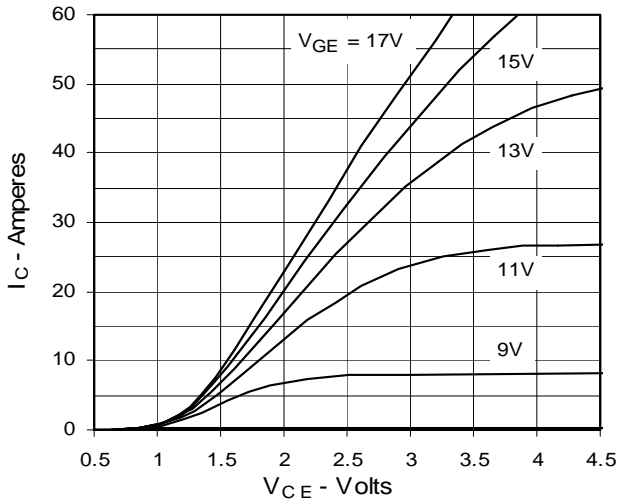
Terminals: 1 - Gate 2 - Drain

Dim.	Millimeter		Inches	
	Min.	Max.	Min.	Max.
A	4.7	5.3	.185	.209
A <sub>1</sub>	2.2	2.54	.087	.102
A <sub>2</sub>	2.2	2.6	.059	.098
b	1.0	1.4	.040	.055
b <sub>1</sub>	1.65	2.13	.065	.084
b <sub>2</sub>	2.87	3.12	.113	.123
C	.4	.8	.016	.031
D	20.80	21.46	.819	.845
E	15.75	16.26	.610	.640
e	5.20	5.72	0.205	0.225
L	19.81	20.32	.780	.800
L <sub>1</sub>		4.50		.177
∅P	3.55	3.65	.140	.144
Q	5.89	6.40	0.232	0.252

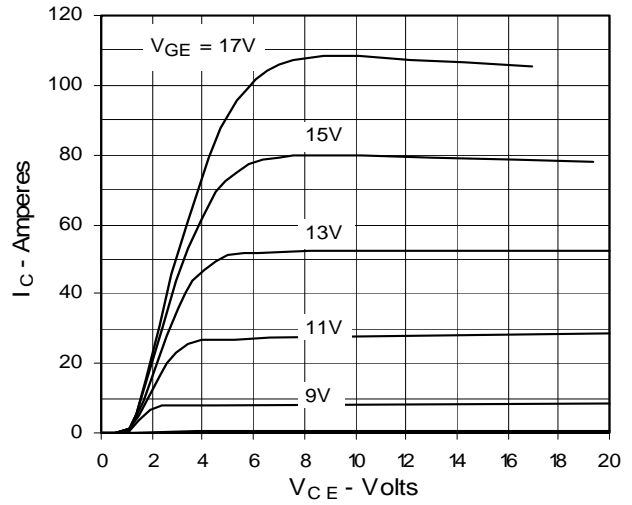
**TO-268 (IXST) Outline**


SYM	INCHES		MILLIMETERS	
	MIN	MAX	MIN	MAX
A	.193	.201	4.90	5.10
A <sub>1</sub>	.106	.114	2.70	2.90
A <sub>2</sub>	.001	.010	0.02	0.25
b	.045	.057	1.15	1.45
b <sub>2</sub>	.075	.083	1.90	2.10
C	.016	.026	0.40	0.65
C <sub>2</sub>	.057	.063	1.45	1.60
D	.543	.551	13.80	14.00
D <sub>1</sub>	.488	.500	12.40	12.70
E	.624	.632	15.85	16.05
E <sub>1</sub>	.524	.535	13.30	13.60
e	.215 BSC		5.45 BSC	
H	.736	.752	18.70	19.10
L	.094	.106	2.40	2.70
L <sub>1</sub>	.047	.055	1.20	1.40
L <sub>2</sub>	.039	.045	1.00	1.15
L <sub>3</sub>	.010 BSC		0.25 BSC	
L <sub>4</sub>	.150	.161	3.80	4.10

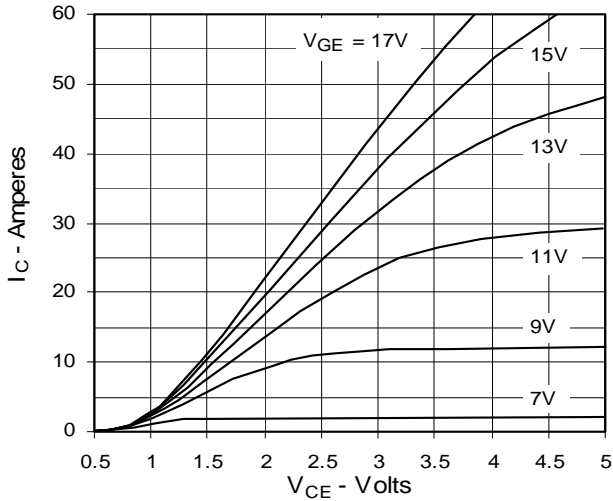
**Fig. 1. Output Characteristics**  
@ 25 °C



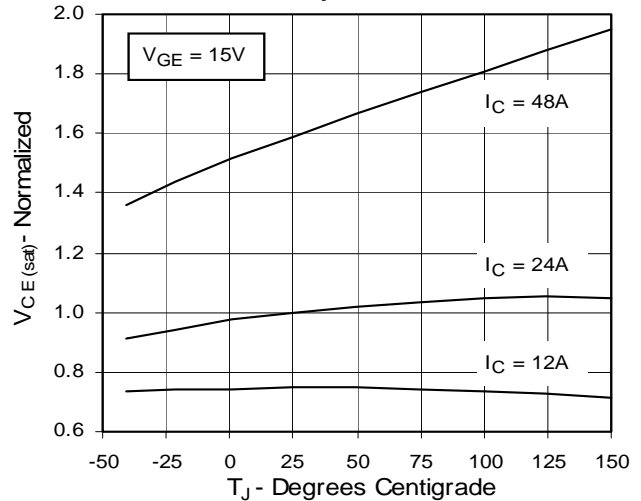
**Fig. 2. Extended Output Characteristics**  
@ 25 °C



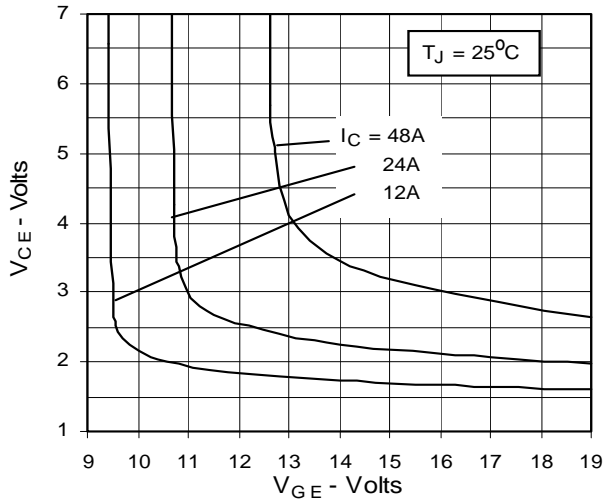
**Fig. 3. Output Characteristics**  
@ 125 °C



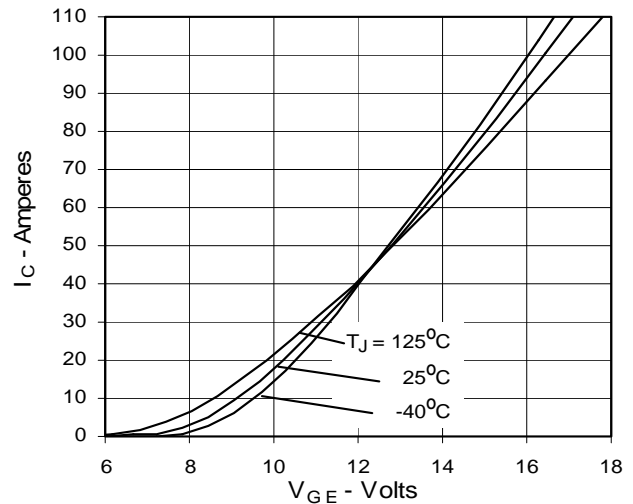
**Fig. 4. Dependence of  $V_{CE(sat)}$  on Temperature**



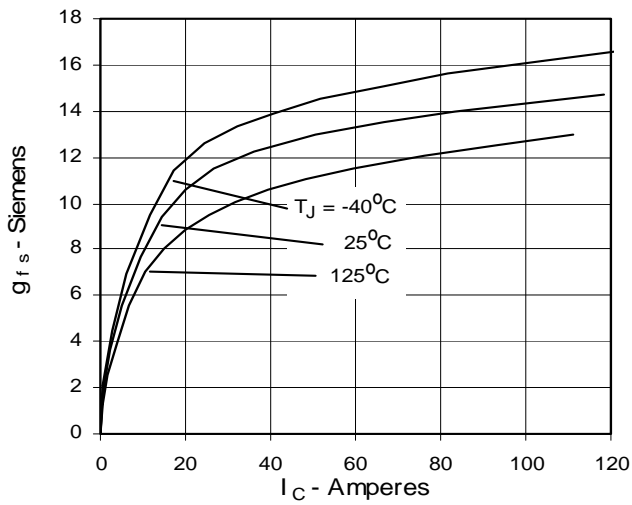
**Fig. 5. Collector-to-Emitter Voltage vs. Gate-to-Emitter voltage**



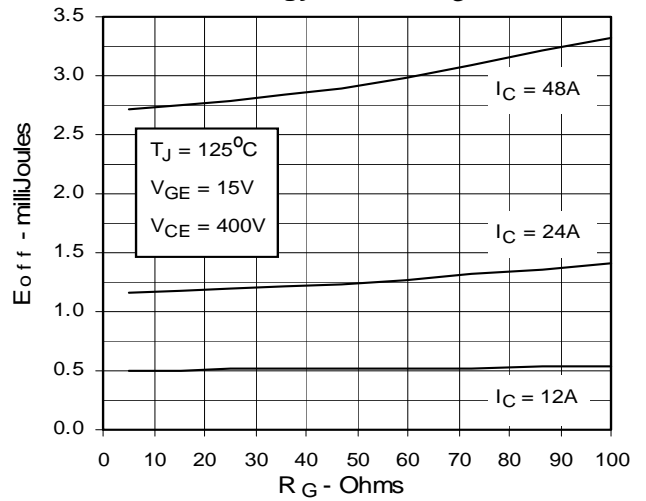
**Fig. 6. Input Admittance**



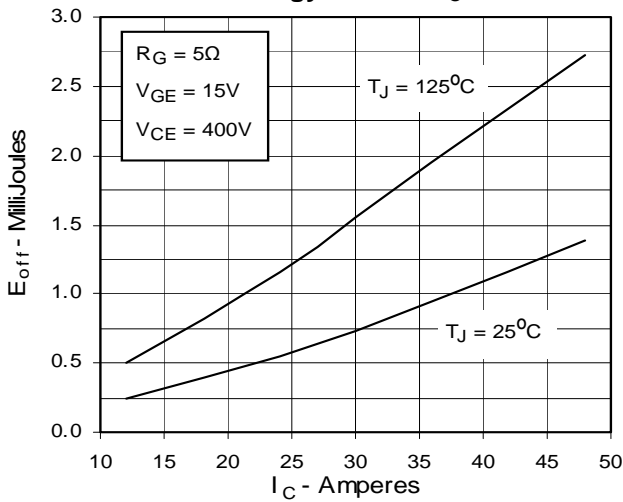
**Fig. 7. Transconductance**



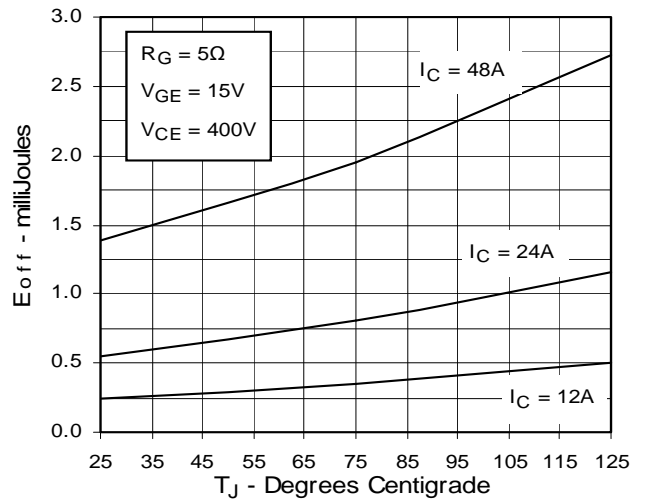
**Fig. 8. Dependence of Turn-off Energy Loss on  $R_G$**



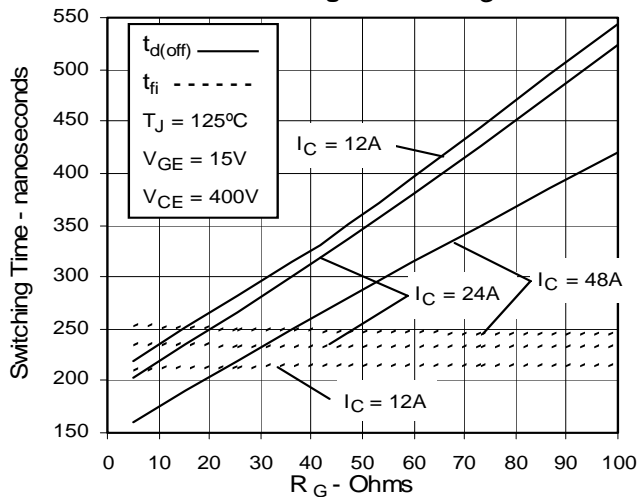
**Fig. 9. Dependence of Turn-Off Energy Loss on  $I_C$**



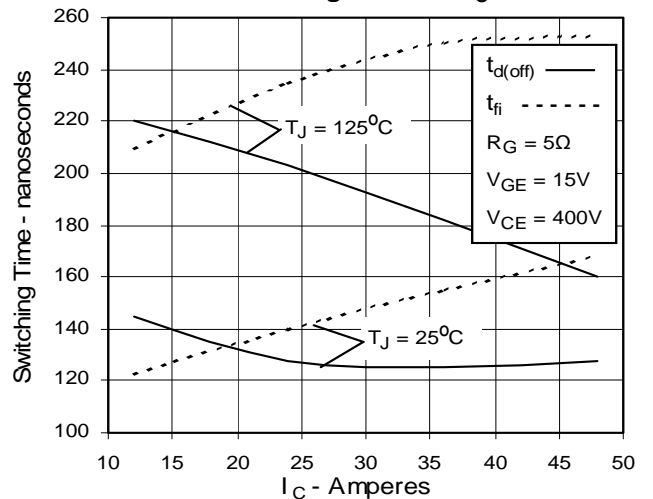
**Fig. 10. Dependence of Turn-off Energy Loss on Temperature**



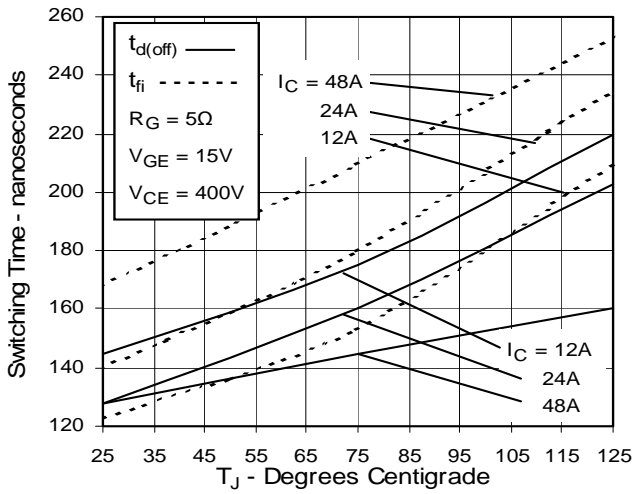
**Fig. 11. Dependence of Turn-off Switching Time on  $R_G$**



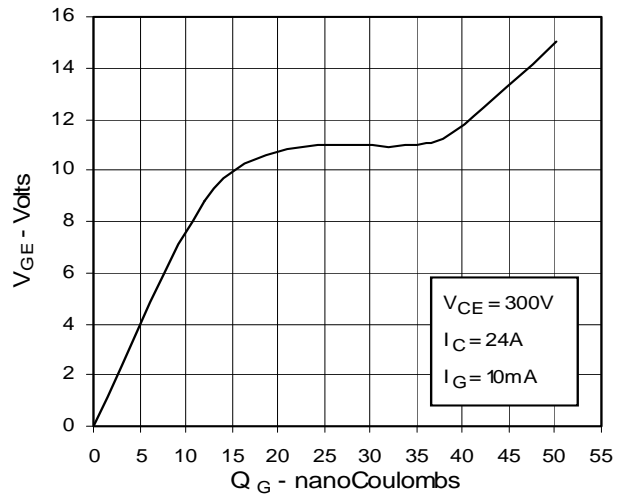
**Fig. 12. Dependence of Turn-off Switching Time on  $I_C$**



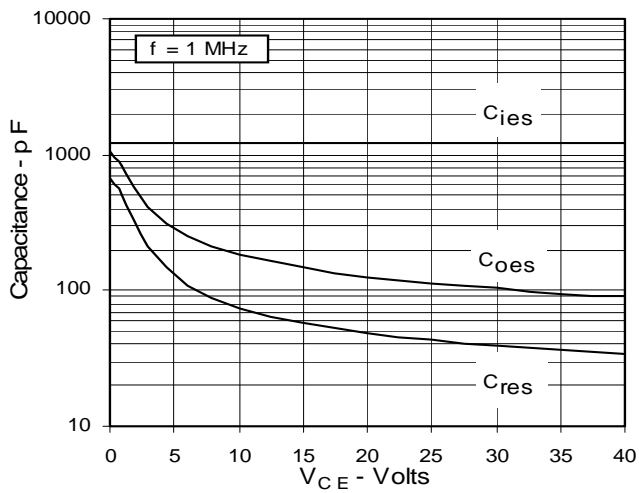
**Fig. 13. Dependence of Turn-off Switching Time on Temperature**



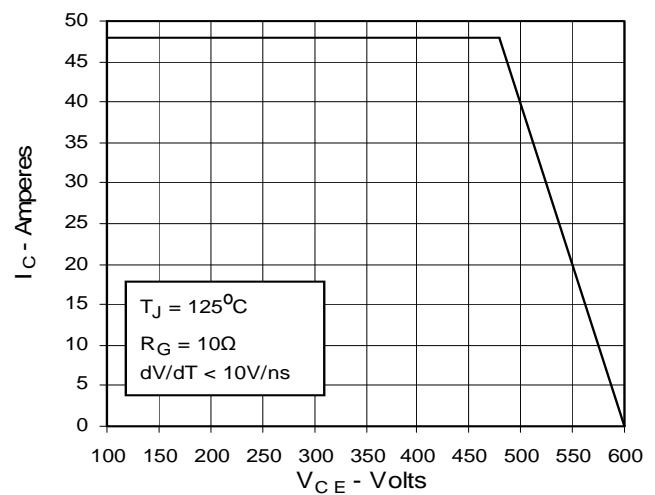
**Fig. 14. Gate Charge**



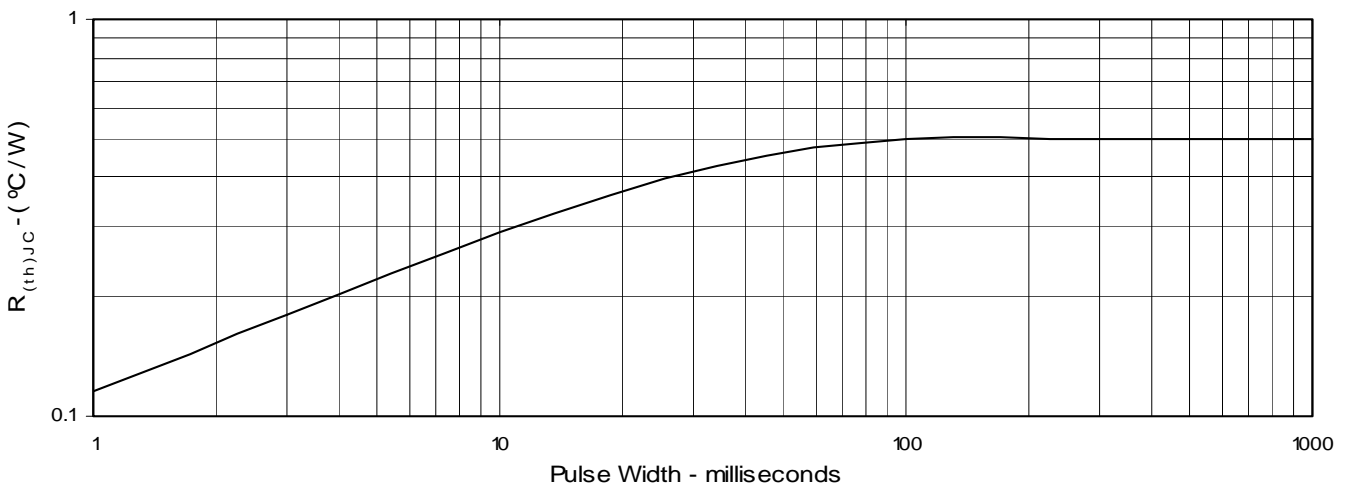
**Fig. 15. Capacitance**

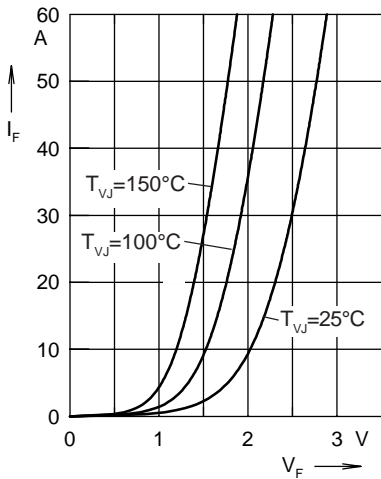


**Fig. 16. Reverse-Bias Safe Operating Area**

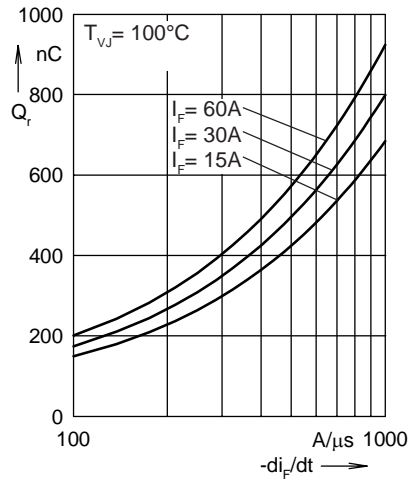


**Fig. 17. Maximum Transient Thermal Resistance**

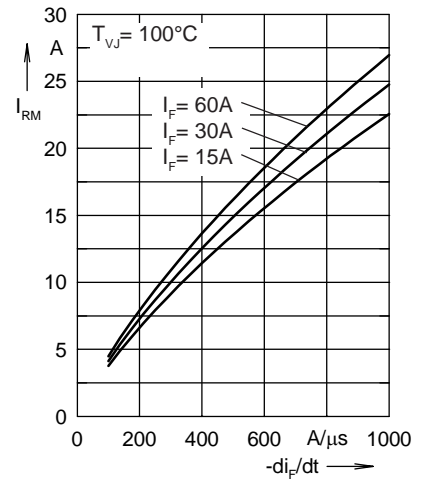




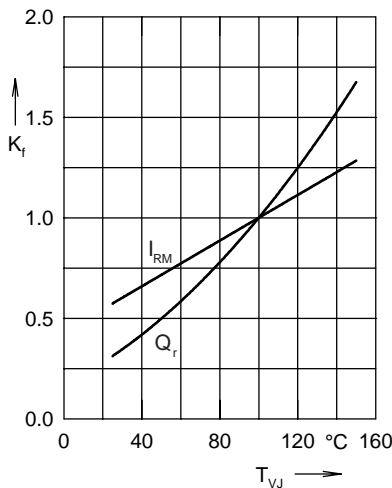
**Fig. 18. Forward current  $I_F$  versus  $V_F$**



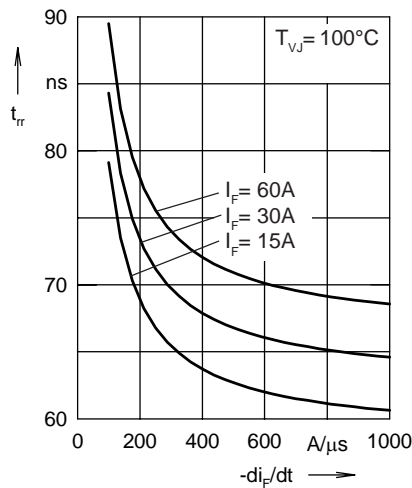
**Fig. 19. Reverse recovery charge**



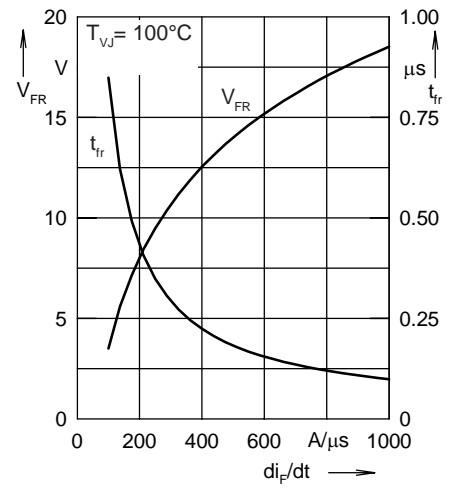
**Fig. 20. Peak reverse current  $I_{RM}$**



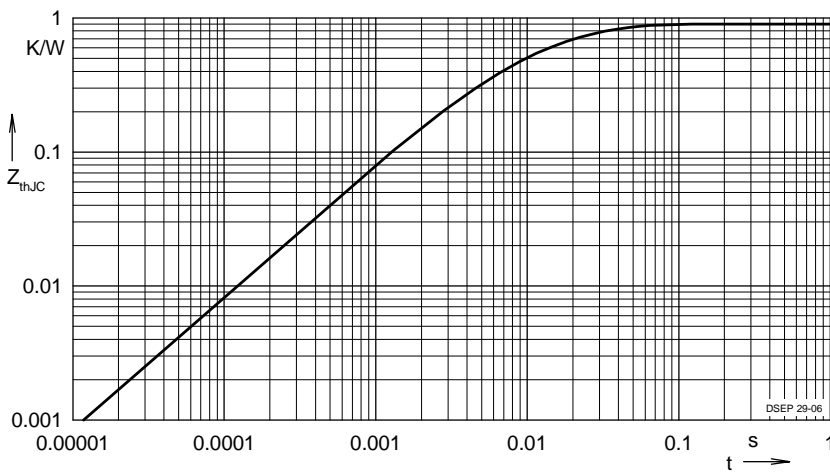
**Fig. 21. Dynamic parameters  $Q_r$ ,  $I_{RM}$**



**Fig. 22. Recovery time  $t_{rr}$  versus**



**Fig. 23. Peak forward voltage  $V_{FR}$**



**Fig. 24. Transient thermal resistance junction to case**

Constants for  $Z_{thjC}$  calculation:

i	$R_{thi}$ (K/W)	$t_i$ (s)
1	0.502	0.0052
2	0.193	0.0003